

Anti-Seize Compound - Apply a small amount of the supplied Anti-Seize Compound to the aluminum joints and to the threads of the U-Bolts to prevent galling.

**BEFORE INSTALLING YOUR NEW ANTENNA, PLEASE BE SURE
TO READ THE ENCLOSED WARNING PAMPHLET.**

CAUTION: *While we strive to remove all burrs from all machined parts, there is always the possibility of sharp edges. We strongly suggest checking the edges and use a fine file, or 400 grit sandpaper, to remove any burrs that may have been left.*

*Tools needed: #1 Phillips screw driver
Small flat blade screw driver
soldering gun or large iron
rosin core solder
large needle nosed pliers
keeper installation tool (supplied with kit)
ruler with metric millimeter markings
marking pencil*

ASSEMBLY INSTRUCTIONS

1) The antenna components should be removed carefully from the shipping container and the individual parts counted and checked for completeness. Be careful to check all tubing pieces for elements and hardware that may be packed inside.

In the following steps, apply a small amount of the supplied Anti-Seize to the boom joints:

2) The boom consists of two aluminum tubing sections. The rear boom section already has the balun & driven element connector attached. Assemble the two boom sections aligning the marks and fasten with 8-32 x 1 3/8" machine screw and hardware.

3) Install all of the element insulators by pressing them into the holes in the boom. They will snap in place and should not fall out. We include a couple of extras just in case!

4) The element bundle contains all of the elements needed for assembly. Take time to inventory each one and check off each dimension with Table 1. Some elements vary by 1 or 2mm in overall length, so extreme care in measuring is called for here. Arrange elements in order of descending size and mark each element with a scribe for proper location of the "keeper" (see Table 1 again and Figure 1). The reflector is the longest element, and each succeeding director is slightly shorter. DIR # 13 is the shortest. The keeper must be installed as shown in Figure 2; using the keeper installation tool supplied, slide the keeper to within a

mm of the scribed line. Note that the keeper is a one-way device only. If you go past the scribed line, you must continue to the element end and start the process over. Place the first keeper on all elements.

See pictures below for keeper orientation. The front side, with the tabs going inward, is the side to push onto the element. The rear side, with the tabs going outward, is the side that faces you. It is the side that goes face down into the element tool.



Keeper Front side

Keeper Rear side

MARK ELEMENT FOR
CORRECT KEEPER
POSITION

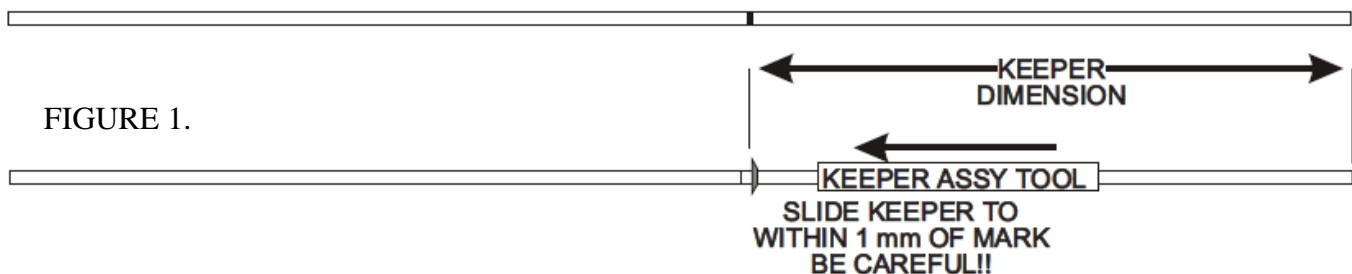

5) You are now ready to install the elements on the boom. You must start at one end and work your way, in order, to the far end of the boom. Lay out the elements in ascending or descending order as appropriate. Note that the driven element is brass rod, but is installed as the other elements. Push element through insulator on one side about $\frac{1}{2}$ " to set locking tabs. Now insert the element from the other side through both insulators and install the second keeper on the opposite side of the boom from the first keeper.

See Figure 3) Check that the element is centered before you snug up both keepers. A positioning error of ± 1 mm. or 0.040" is acceptable. At this point, if you tighten the keepers and the element is not centered, you will have to cut one of the keepers to remove the element and start again. Some extra keepers are supplied, but care is definitely required here. Check your work as you go! Proceed with the next element in similar fashion. Note that the driven element is brass tube, but otherwise is installed the same as the other elements. Check off each element on Table 1 to monitor your progress. Double-check element lengths one last time before final installation on the boom.

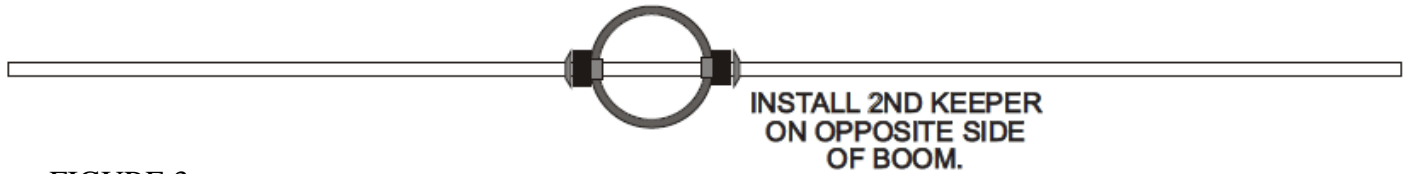

FIGURE 3.

- 6) The driven element and T-Match assembly are built as shown in Figure 4 and the photographs below.
- 7) Locate the two brass T-arms. Both are preformed- one is straight while the other is bent and on one end. Locate also the brass T-match bars, and position them on the brass driven element as shown in Figure 4.
- 8) Referring to photo 1, push the pre-formed T-arm into the hole in the standoff insulator which has the hole rotated up slightly for easier installation.

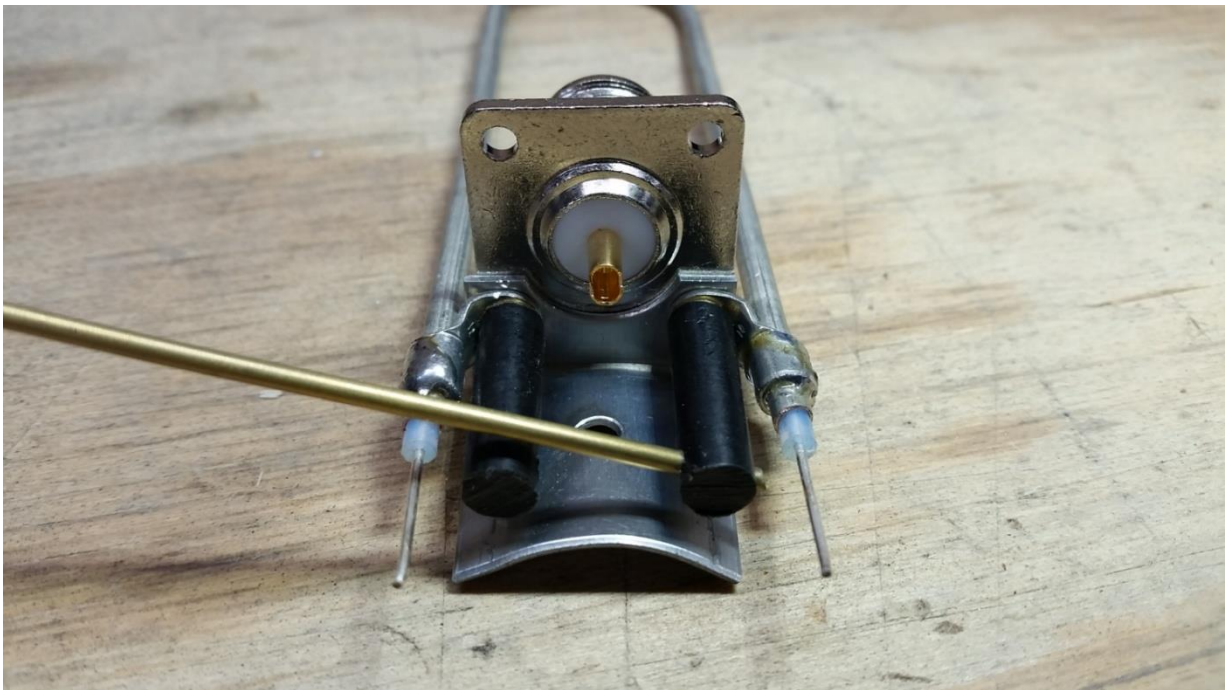

Photo 1

- 9) Push the T-arm all the way through as shown in photo 2.

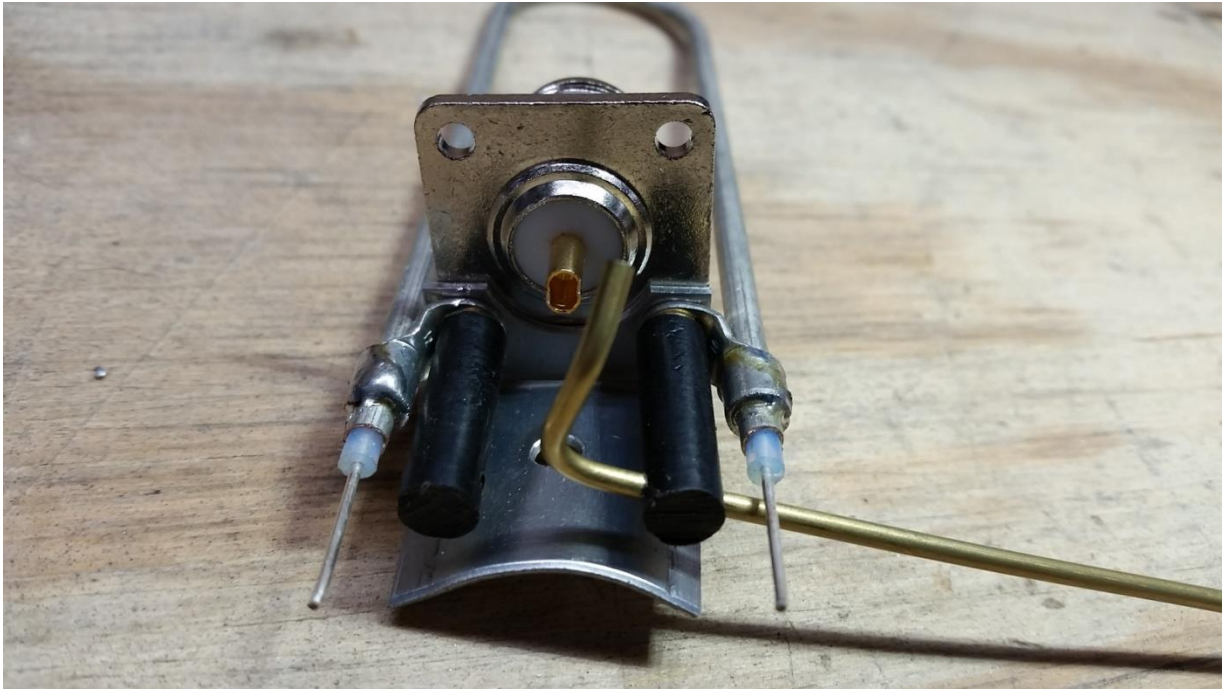

Photo 2

- 10) Once the T-arm is inserted all the way as in photo 2, slightly loosen the screw holding the insulator using a screw driver.
- 11) Rotate the T-arm so the end of the T-arm fits into the solder cup on the N connector (see photo 3) and tighten the screw.

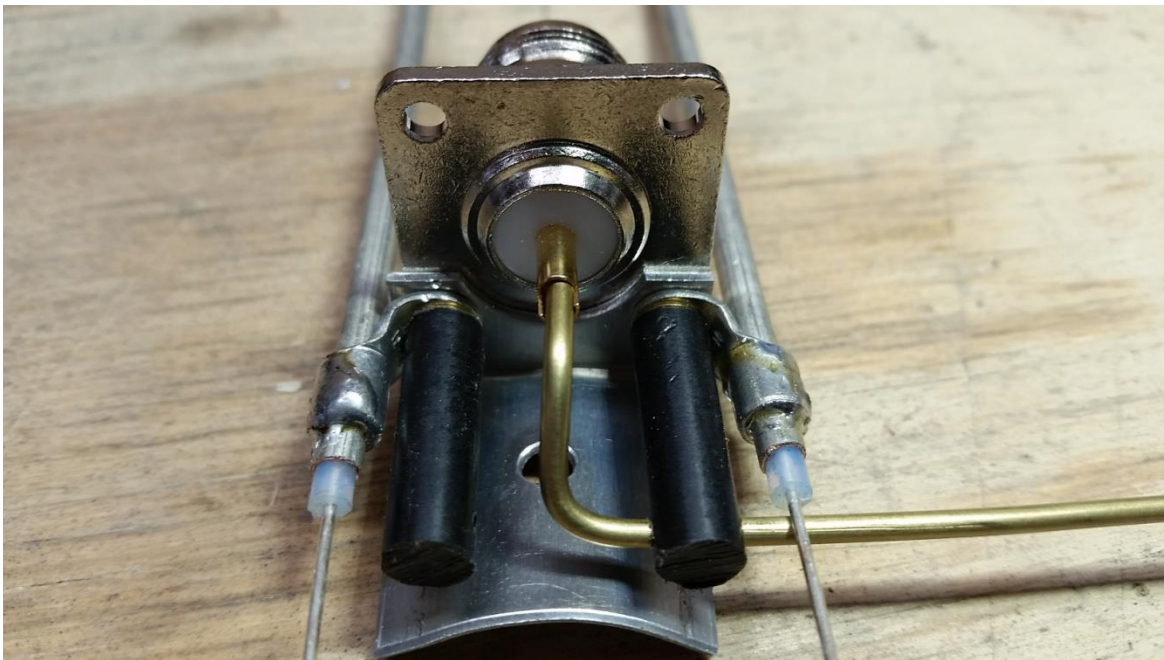

Photo 3

- 12) Next, insert the straight T-arm into the other standoff insulator until it is flush with the inside edge (see photo 4).

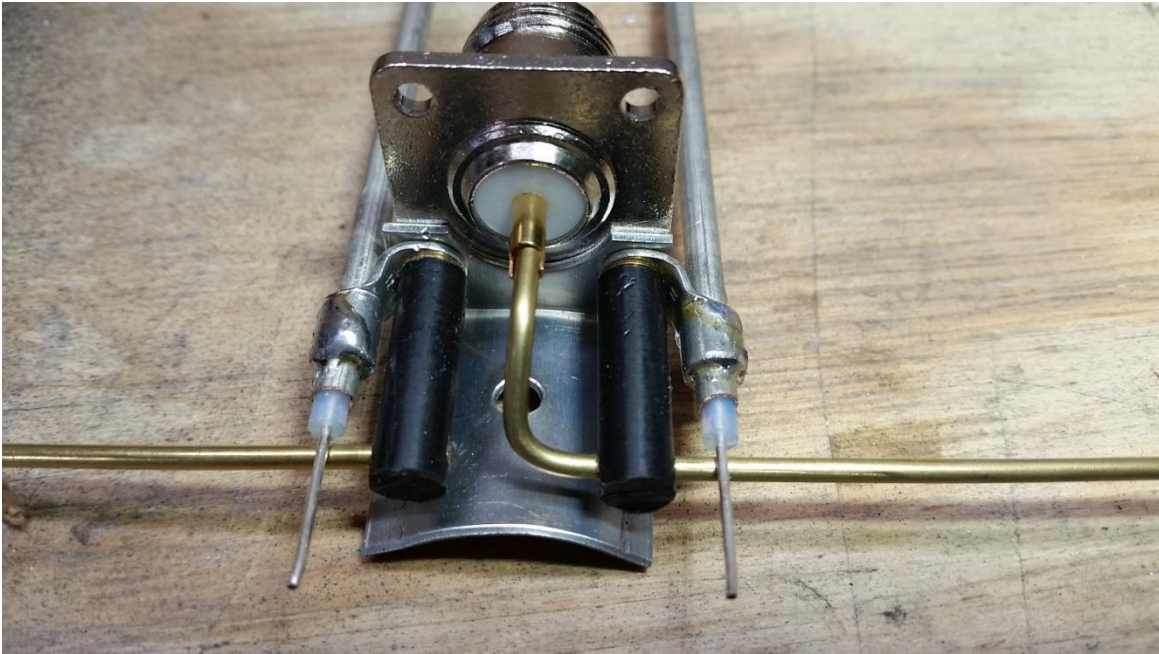

Photo 4

- 13) Last, wrap the balun center conductor around the T-arms and solder (see photo 5)



Photo 5

14) Slide the T-match bars over the driven element and T-arms. Measuring from the boom to the inside of the shorting bar, the dimension below is a good starting point; however, to ensure the minimum SWR at your operating frequency, we recommend using an antenna analyzer or SWR bridge to obtain the lowest SWR. Note: The ends of the T-arms that extend past the shorting bars can be bent up toward the driven element, or down away from the driven element to obtain the best SWR. If bending the T-arms closer to the driven element makes the SWR better, remove 5 mm from each T-arm end using a large pair of wire cutters. 105-110 mm is the minimum length.

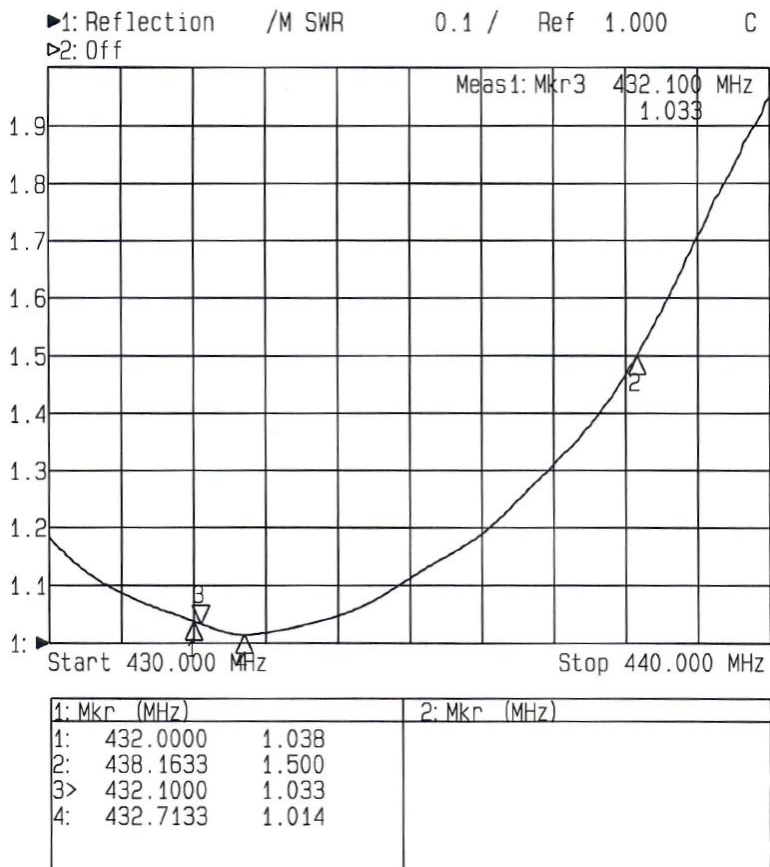
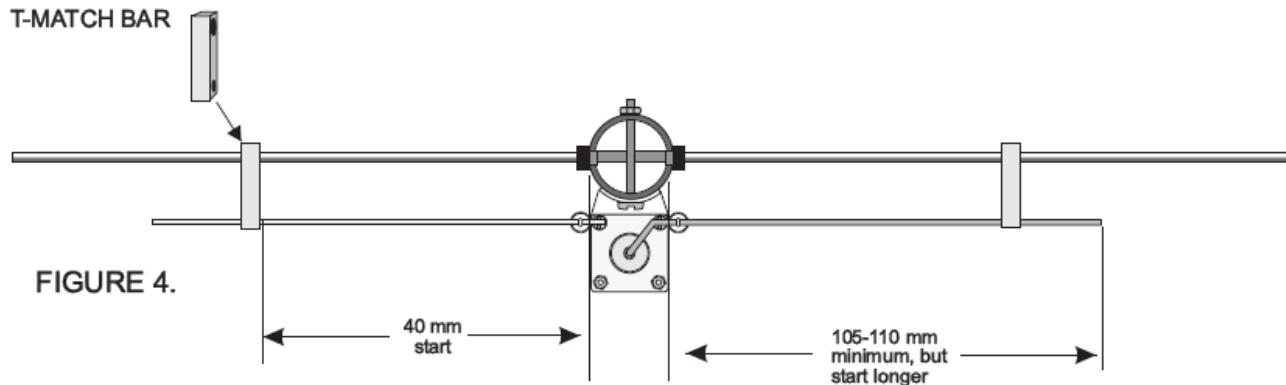

T-arms – 105 mm
 Shorting Bars – 57 mm
 1.5:1 SWR bandwidth

Note: The lowest SWR is always just above the operating frequency. When antenna gets wet, the SWR will drop.

If you are installing multiple antennas, please be sure that you build each antenna with the same T-match wire orientation. In the above drawing, the center pin goes to the right hand side of the antenna as viewed from the back of the connector. Make sure both antennas do the same! Proper phase relationship is very important here!

If you wish to check your work, now is the time to apply power to the antenna. Any work around RF energy should be done carefully. We do not recommend standing next to an antenna with many watts of 432 MHz energy radiating around it. An MFJ 259 analyzer, Comet CAA-500 or VNA can also be used. The T-arm shorting bars may be adjusted with power applied and the point of best match can be found quickly, easily and more accurately than that with an amateur transmitter and wattmeter connected. Generally, good watt meters can reliably indicate SWR down to about 1.2:1.

The aperture of this antenna is large enough so that you must elevate the antenna a minimum of 7 feet or 2.1m above the ground. Point the antenna so that there are no "reflectors" or obstructions for 100 feet directly in front of the beam. A better method would be to point the antenna straight up toward the sky. Support the rear of the antenna on a wooden or metal pole or tube, and tie or guy the antenna boom with very light string or line. Now the driven element will be at arm level, and ground effects are removed. Most locations are pretty clear straight over head as well!

Install a short length of coax (1/2 wave is ideal... the antenna impedance will repeat each half wave from the antenna regardless of coax imperfections) between the coax connector and your bridge or wattmeter. If you are using your transmitter for an RF source, apply power and observe the reflected power. Turn off the power and adjust the T-Match bars equally in small increments. 1/8" or 3mm is a good starting point. Apply power again and observe results. If it got better, keep going. If it degraded, change the direction of your T-Match movement program and recheck your SWR. At some point you will observe a null in reflected power. When you have found it, tighten the set screws on both the driven element and the T-arms with the supplied hex wrench.

Brass, copper and tin lead solder will oxidize in the weather and over the years' performance can degrade. It is a good idea to spray your handiwork with a good grade of clear paint sealant. As a general rule, the slower drying sprays tend to be more enduring. Rustoleum "Clear Seal" or Krylon clear sprays are recommended. A few light coats work better than one big one. Be sure to cover the connector before spraying.

DO NOT, UNDER ANY CIRCUMSTANCES, APPLY ANY TYPE OF SEALANT OR COATING TO THE DRIVEN ELEMENT, T-ARMS OR CONNECTOR ASSEMBLY, OTHER THAN KRYLON® CLEAR COAT. ANY OTHER COATING WILL ADVERSELY AFFECT THE SWR AND VOID YOUR WARRANTY.

You are now ready to install your new antenna. Be careful when you dress the coax down the boom. Keep the coax away from any elements. Tape the cable tightly and securely to the boom. The Boom-to Mast plate has V shaped grooves to fit mast sizes up to 2" maximum. The small 1/4" U bolts are used to attach the boom to the mounting plate. Use the supplied lock washers. It is a good idea to apply a small amount the anti-seize compound to the stainless steel threads under the hex nuts to prevent galling of stainless steel.

TABLE 1. ELEMENT TABLE

<i>Element Description</i>	<i>Element Length mm. +/- 1mm</i>	<i>Keeper Half Length mm.</i>
Reflector	346	158
Driven Element	333	152
Director #1	321	146.5
Director #2	312	142
Director #3	305	138.5
Director #4	301	136.5
Director #5	297	135
Director #6	295	133.5
Director #7	294	133
Director #8	292	132
Director #9	290	131.5
Director #10	288	130.5
Director #11	285	128.5
Director #12	284	128
Director #13	283	127.5

All measurements are in Millimeters.
Lengths are +/- 1 Millimeter.

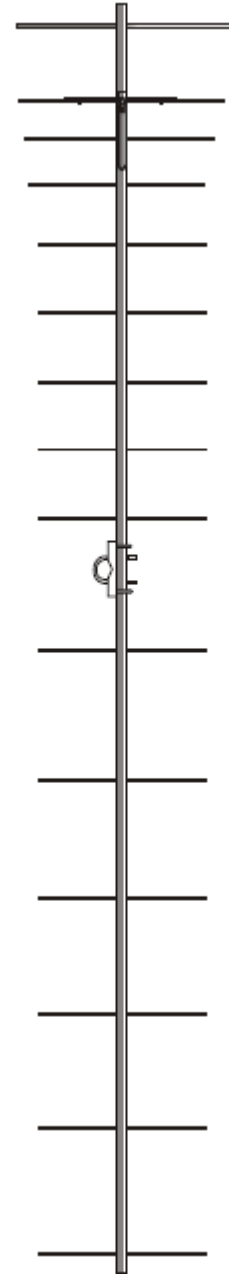

Directive Systems Warranty Policy

All Directive Systems antennas are built with the finest materials available. We take great pride in building a quality product that will give years of good service and performance. If there is a defect in materials or workmanship within 90 days of purchase, Directive Systems will repair or replace the defective part, free of charge, to the original purchaser. **DO NOT RETURN ANYTHING WITHOUT PRIOR AUTHORIZATION FROM DIRECTIVE SYSTEMS.** Please contact us either by phone or email describing the problem and we will work to resolve it.

If, after examining a new antenna you received, you are not satisfied, contact us immediately for return authorization and refund. **ANY ANTENNA THAT HAS BEEN MODIFIED WILL BE SUBJECT TO A RESTOCKING CHARGE. IF AN ANTENNA IS SO MODIFIED AS TO MAKE IT UNUSABLE, DIRECTIVE SYSTEMS RESERVES THE RIGHT TO REFUSE TO ACCEPT THE ANTENNA FOR RETURN.**